

Video Solution on Website:-

<https://physicsaholics.com/home/courseDetails/82>

Video Solution on YouTube:-

https://youtu.be/aZsjjVC_A_s

Written Solution on Website:-

<https://physicsaholics.com/note/notesDetailis/20>

- Q 1. A tube 1 cm^2 in cross-section is attached to the top of a vessel 1 cm high and cross-section 100 cm^2 . Water fills the system upto a height of 100 cm from the bottom of the vessel. The force exerted by the liquid at the bottom of the vessel is:
 $g = 10 \text{ m/s}^2$

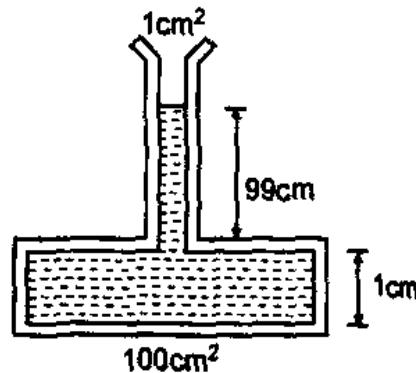

- (a) 1000 N (b) 990 N (c) 900 N (d) 100 N
- Q 2. A wooden cube just floats inside water when a 200 g mass is placed on it-when the mass is removed, the cube is 2 cm above the water level, what is the size of each sides of the cube?
 (a) 6 cm (b) 8 cm (c) 10 cm (d) 12 cm
- Q 3. A piece of steel has a weight w in air, w_1 when completely immersed in water and w_2 when completely immersed in an unknown liquid. The relative density (specific gravity) of liquid is:
 (a) $\frac{w-w_1}{w-w_2}$ (b) $\frac{w-w_2}{w-w_1}$ (c) $\frac{w_1-w_2}{w-w_1}$ (d) $\frac{w_1-w_2}{w-w_2}$
- Q 4. A block of iron is kept at the bottom of a bucket full of water at 2°C . The water exerts bouyant force on the block. If the temperature of water is increased by 1°C the temperature of iron block also increased by 1°C . The buoyant force on the block by water.
 (a) will increase
 (b) will decrease
 (c) will not change
 (d) may decrease or increase depending on the values of their coefficient of expansion

Comprehension (for Q.5)

With the help of Archimede's principle, one can understand the floating nature

and defects in metal formation. One can easily find out the amount of space left hollow in a sphere. For a body to float, there should be a balance between the weight of the body and the upthrust. The apparent weight felt differs based on the volume immersed in the liquid. More than one liquid may also balance the mass while floating. In a frame accelerated down with 'a' any mass will experience a normal force of $m(g - a)$.

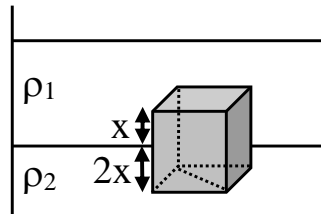

- Q 5. For a cubical block (ρ) to float in a pair of liquids of density ρ_1 and ρ_2 as shown, the relation between ρ , ρ_1 and ρ_2 is—
- (a) $\rho = \frac{\rho_1 + \rho_2}{2}$ (b) $\rho = \frac{2\rho_2 + \rho_1}{3}$ (c) $\rho = \frac{2\rho_1 + \rho_2}{2}$ (d) $\rho = \frac{\rho_1 + \rho_2}{3}$
- Q 6. If the container in which a body floats in a liquid falls under gravity, the upthrust felt by the body will be (symbols carry usual meaning)—
- (a) zero (b) $V_l \rho_l g$ (c) $\frac{V_l}{2} \rho_l g$ (d) $V_b \rho_b g$
- Q 7. An ice cube floats in a cup of water. After all the ice melts, the level in the cup will —
- (a) rise
(b) fall
(c) remains unchanged
(d) cannot be confirmed without knowing density of steel ball
- Q 8. An ice cube holding a steel ball floats in a cup of water. After all the ice melts, the level in the cup will —
- (a) rise
(b) fall
(c) remains unchanged
(d) cannot be confirmed without knowing density of steel ball
- Q 9. A cylinder block of length $L = 1\text{m}$ is floating in two immiscible liquids. Part of block inside liquid (1) is $\frac{1}{4}\text{m}$ and in liquid (2) is $\frac{1}{4}\text{m}$. Area of cross-section of block is A . Densities of liquid (1) & (2) are ρ and 2ρ respectively —

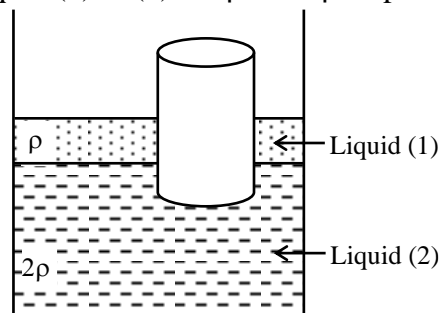

- (a) Density of block is $3\rho/4$
(b) Force exerted by liquid (1) on block is $\rho Ag/4$

- (c) Block is depressed so that it is just completely immersed in liquid (1) and released. A initial acceleration of block is $\frac{4}{3}g$
 (d) In option (c) force exerted by liquid (2) on block is $\frac{3}{2}\rho Ag$

Q 10. A stick is tied to the floor of the water tank with a string as shown in the figure. The length of stick is 2m. Area of cross-section of stick is 10^{-3} m^2 . Specific gravity of stick is 0.25. Take $g = 10 \text{ m/s}^2$. Then –

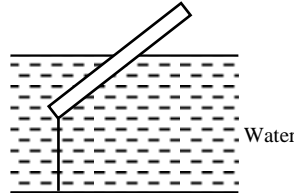

- (a) Tension in the string is 5N
 (b) Buoyancy force acting on stick is 10 N
 (c) Length of stick immersed in water is 1m
 (d) When string is cut initial acceleration of stick is 10 m/s^2

Comprehension (Q11 to Q13)

Equal volumes and different masses of two blocks are in equilibrium on a lever. (case 1) When the blocks are immersed in a liquid then Buoyancy force acting on blocks are F_1 and F_2 . (case 2)

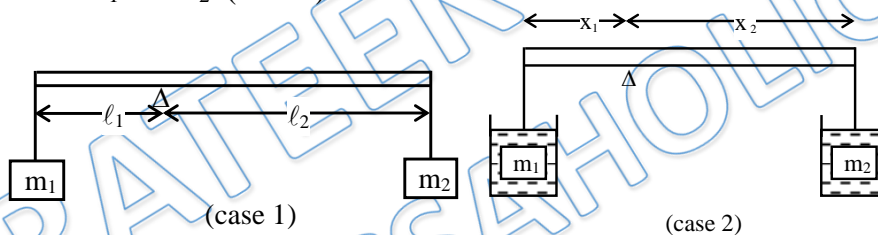

Q 11. In case (1) which of following is true –
 (a) $m_1 = m_2$ (b) $m_1 l_1 = m_2 l_2$
 (c) $\frac{m_1}{l_1} = \frac{m_2}{l_2}$ (d) $\frac{m_1 + m_2}{m_1} = \frac{l_1 + l_2}{l_2}$

Q 12. Buoyancy force acting on the two blocks F_1 and F_2 satisfy the following relation –
 (a) $F_1 m_1 = F_2 m_2$ (b) $F_1 = F_2$
 (c) $F_1 l_1 = F_2 l_2$ (d) $F_1 l_2 = F_2 l_1$

Q 13. In case (2) if the equilibrium is restored at positions x_1 and x_2 then –
 (a) $\frac{x_1}{x_2} = \frac{m_2}{m_1}$ (b) $\frac{x_1}{x_2} = \frac{m_2 g - F_1}{m_1 g - F_1}$
 (c) $\frac{x_1}{x_2} = \frac{F_1}{F_2}$ (d) $\frac{x_1}{x_2} = \frac{F_2}{F_1}$

Q 14. A slender homogeneous rod of length $2L$ floats partly immersed in water, being supported by a string fastened to one of its ends, as shown. The specific gravity of the rod is 0.75. The length of rod that extends out of water is –

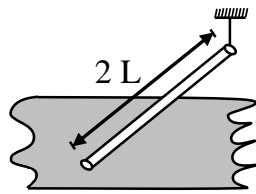

(a) L

(b) $L/2$

(c) $L/4$

(d) $3L$

Comprehension (Q 15 to Q17)

A cylindrical container of length L is full to the brim with a liquid which has mass density ρ . It is placed on a weight-scale; the scale reading is W . A light ball which would float on the liquid if allowed to do so, of volume V and mass m is pushed gently down and held beneath the surface of the liquid with a rigid rod of negligible volume as shown on the left.

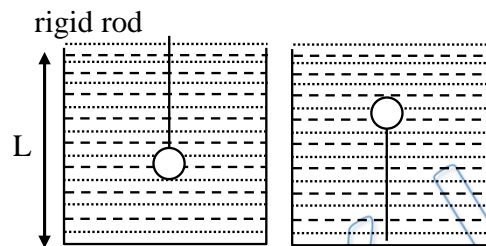

Q 15. What is the reading of the scale when the ball is fully immersed ?

(a) $W - \rho Vg$

(b) W

(c) $W + mg - \rho Vg$

(d) None

Q 16. If instead of being pushed down by a rod, the ball is held in place by a thin string attached to the bottom of the container as shown on the right. What is the tension T in the string—

(a) $(\rho V - m)g$

(b) ρVg

(c) mg

(d) None

Q 17. What is the reading on the scale (refer above question)

(a) $W - \rho Vg$

(b) W

(c) $W + mg - \rho Vg$

(d) None



Answer Key

Q.1 d	Q.2 c	Q.3 b	Q.4 a	Q.5 b
Q.6 a	Q.7 c	Q.8 b	Q.9 a, c	Q.10 a, b, c, d
Q.11 b	Q.12 b	Q.13 b	Q.14 a	Q.15 b
Q.16 a	Q.17 c			

PRATEEK JAIN
PHYSICSAHOLICS